

Plisse „PL 32 D, PL 33 D“

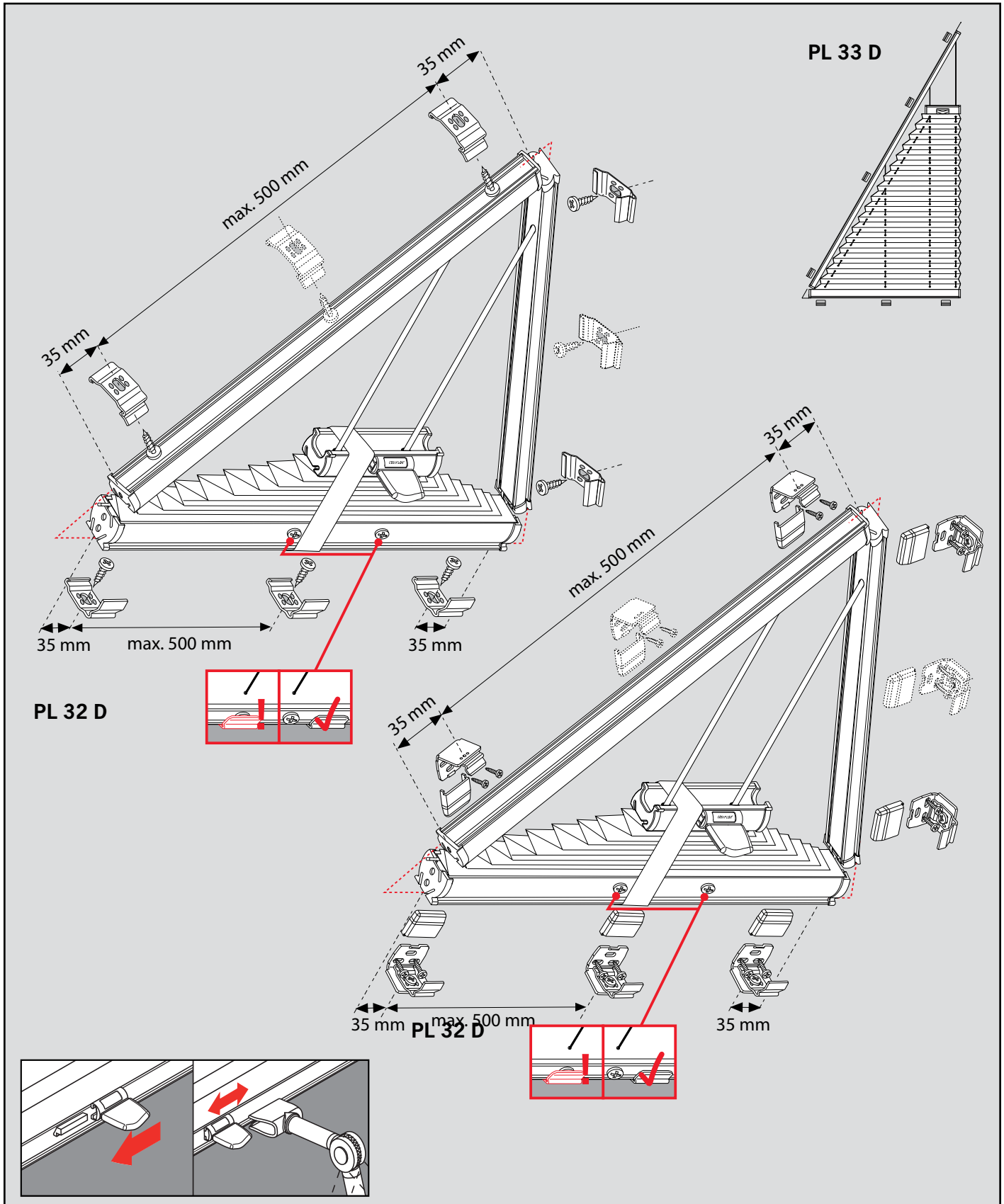

Důležité! Tento návod je platný současně s instrukcemi na údržbu!
Wichtig! Bitte mit der Pflegeanleitung aufbewahren!
Important! Please keep together with care instructions!
Belangrijk! A.u.b. bij de gebruiksaanwijzing bewaren!

Important! Conserver ensemble avec les conseils d'entretien!
Importante! Conservare con le istruzioni per la manutenzione!
Ważne! Proszę przechowywać z instrukcją pielęgnacji!
Внимание! Хранить вместе с инструкцией по эксплуатации!



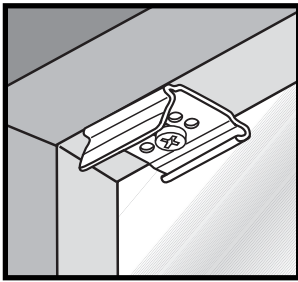

Montáž mezi zasklívací lišty
Falzmontage,
Top fixing,
Bevestiging in de sponning,
Dans la feuillure,
Montaggio nella piegatura,
Montaż w świetle szyby,
Монтаж в проем



Montáž • Montage
Fitting • Montaggio
Montaż • Монтаж

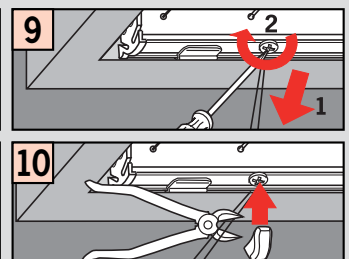
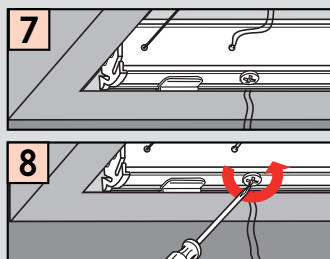
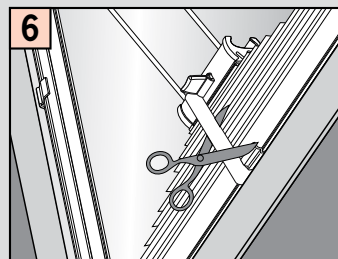
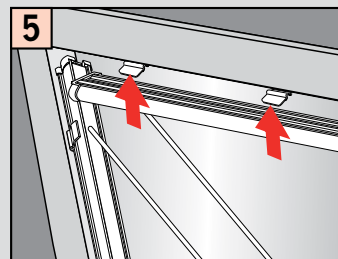
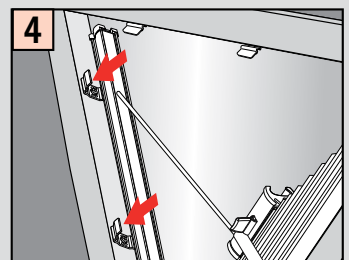
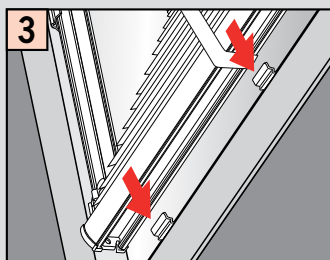
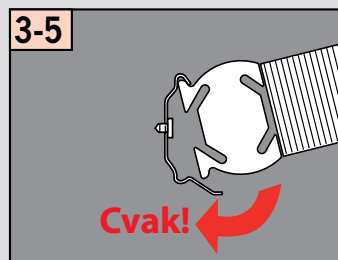
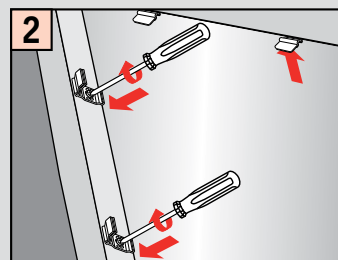
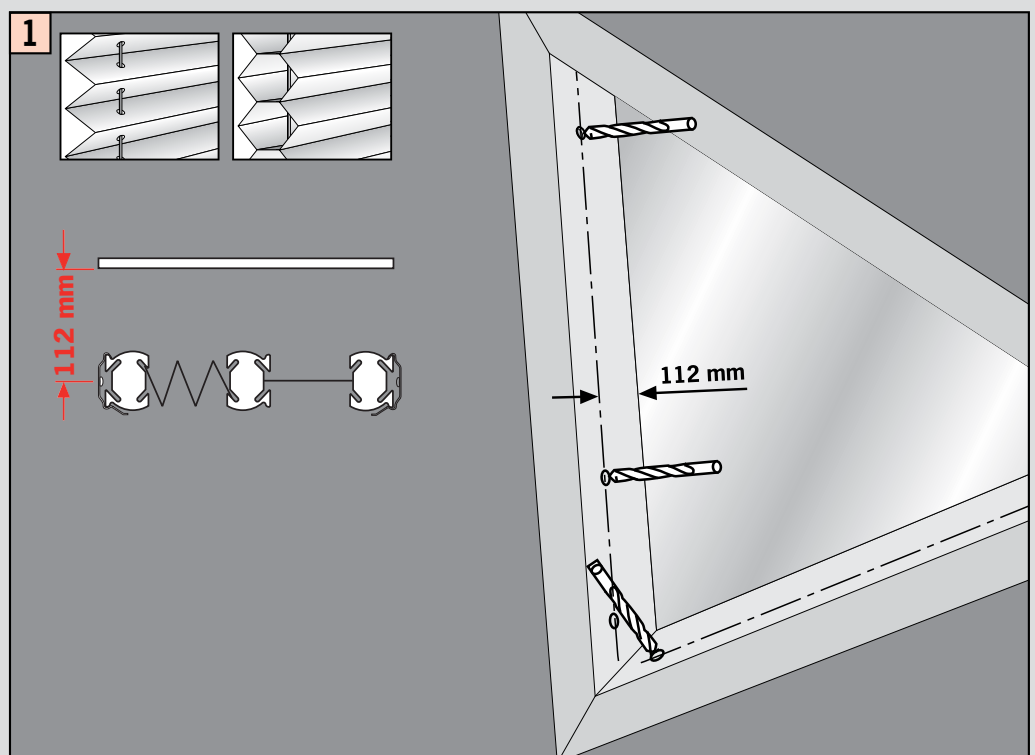

Demontáž • Demontage • Disassembly • Démontage
Smontaggio • Demontaž • Демонтаж

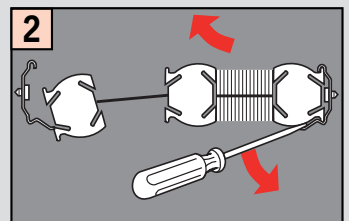
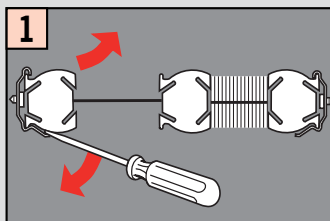

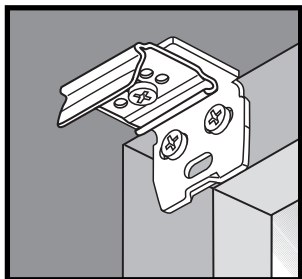

Montáž na rám okna (pomocí stěnového úhelníku)
Winkelmontage,
Face fixing,
Bevestiging met hoeksteun,
Avec equerre de fixation,
Montaggio mediante angolare,
Montaż frontalny (nawierzchniowy),
Монтаж на проем

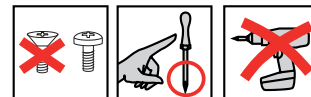

Montáž • Montage
Fitting • Montaggio
Montaż • Монтаж

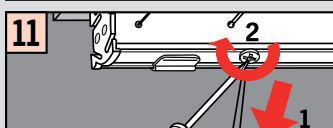
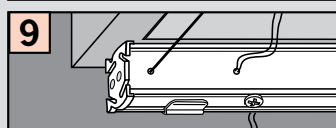
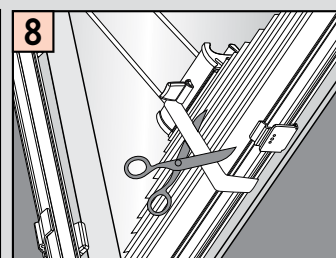
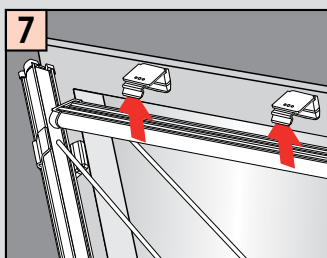
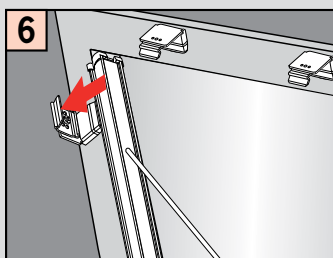
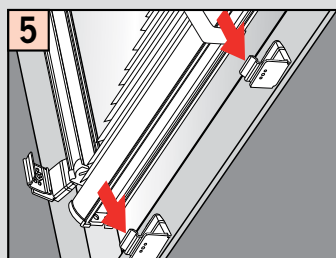
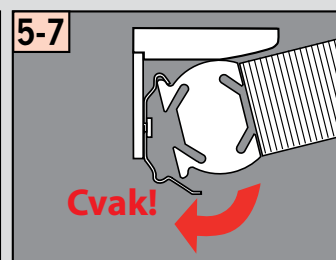
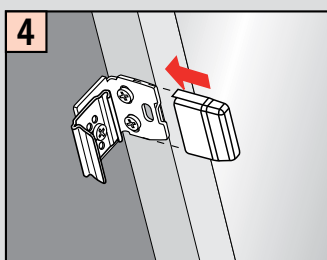
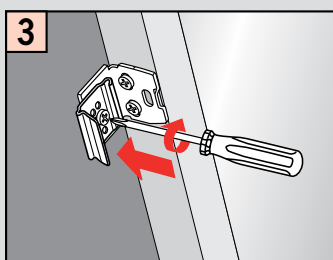
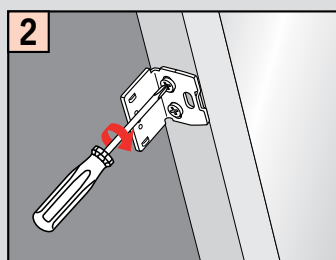
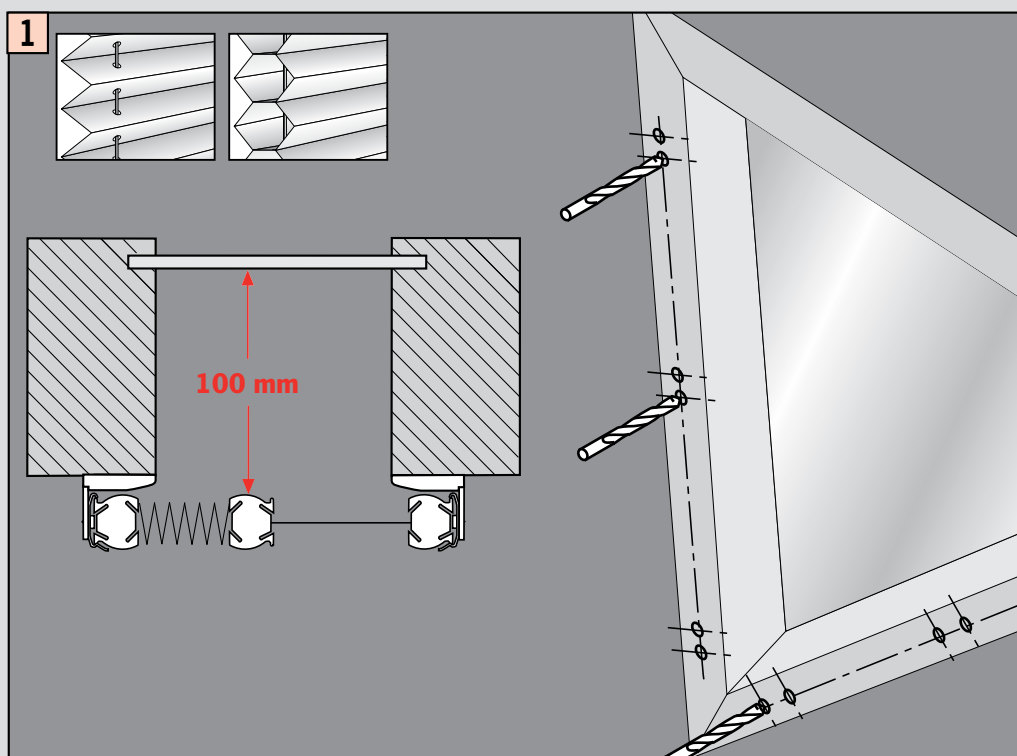

Demontáž • Demontage • Disassembly • Démontage
Smontaggio • Demontaž • Демонтаж

